

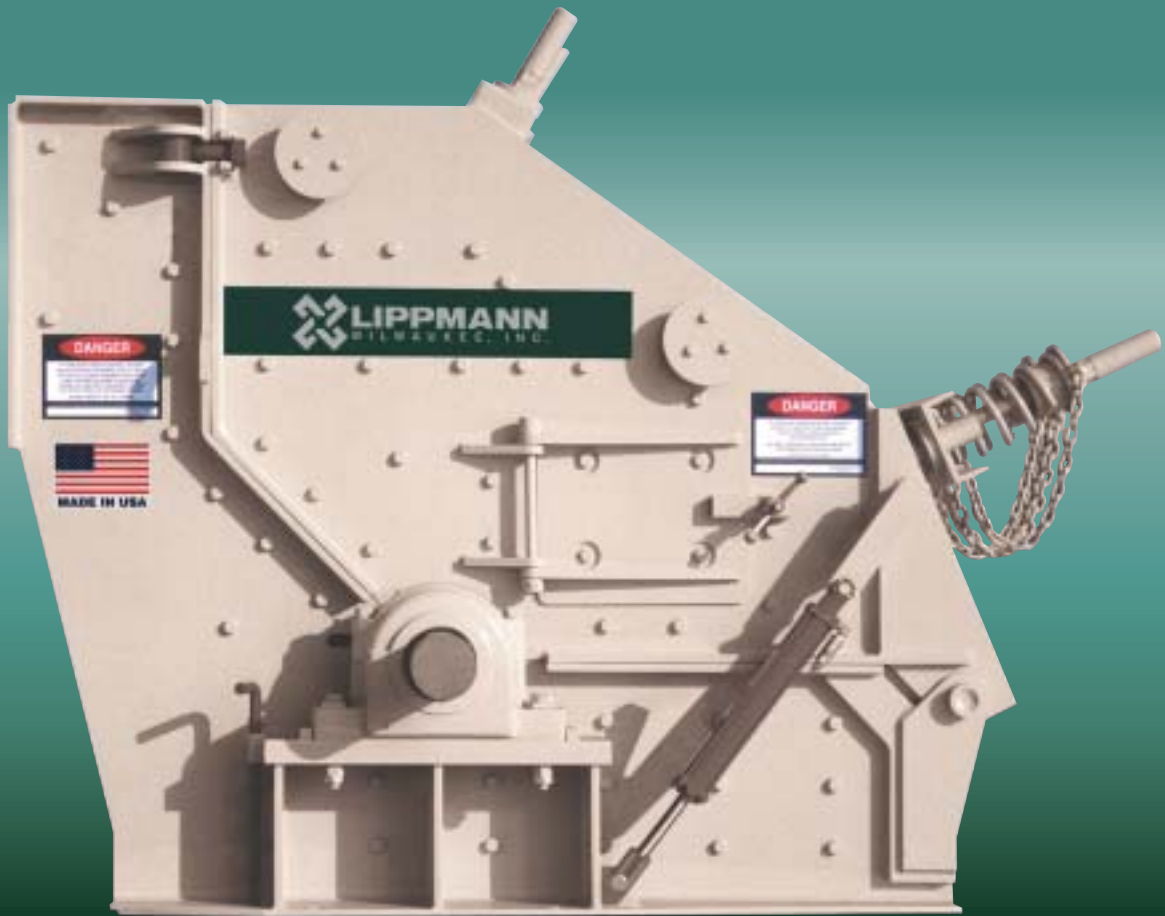

LIPPMANN

MILWAUKEE, INC.



IMPACT CRUSHERS

LIPPMANN HORIZONTAL IMPACT CRUSHERS PROVIDE LOW COST, HIGH PRODUCTION, SIMPLICITY OF DESIGN



LIPPMANN IMPACT CRUSHERS... GREATER RELIABILITY, YOUR BEST VALUE

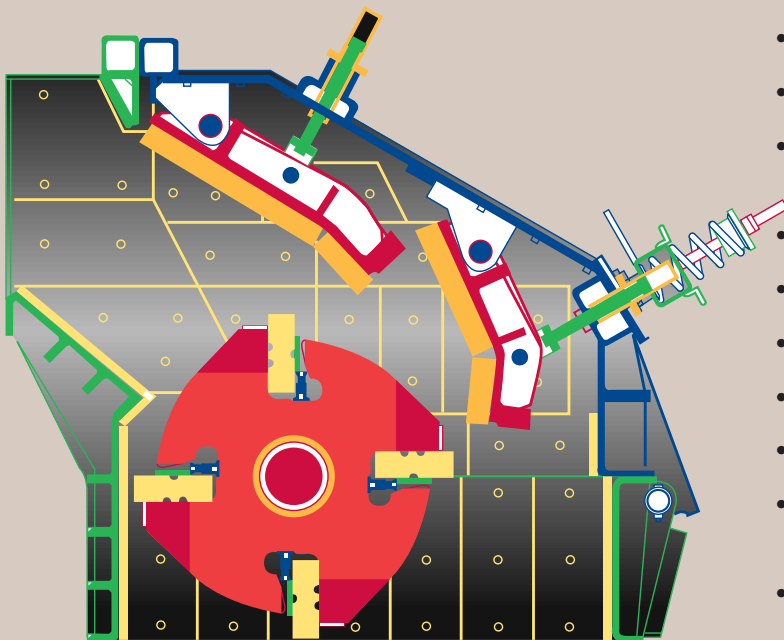

- Andreas Type Impact Crusher Design.
- Lippmann Impact Crushers Produce a Highly Cubical Product.
- High Ratio of Reduction.
- Hammers Have Four Crushing Positions to Maintain a More Constant Gradation and Greater Top Size Control.
- No Weld Build-Up Required on Wear Surfaces.
- Less Capital Outlay Than Competitive Type Crushers.
- High Degree of Product Size Control.
- Long Life of Wear Components Due to Advanced Metallurgy.
- Ideal for Portable Mounting.
- One Gravity and One Spring Loaded Curtain With Optional Third Curtain. Easy Adjustment from Exterior of Crusher.
- Maintenance Thru Inspection Doors or by Hydraulically Opened Hood. Electric/Hydraulic Power Unit Standard.

FIELD PROVEN EXPERIENCE

Lippmann impactors have proven to be rugged, high performance and cost effective solutions in a variety of applications. Our customers will testify to both outstanding service and investment value. Lippmann impactors are successfully crushing a wide range of materials such as



limestone, dolomite, gravel, basalt, copper reverts, concrete and asphalt. Whether you need a portable, skid-mounted, or stationary impact crushing plant, we have the optimum, innovative solution for your specific needs.



Lippmann designs and supplies primary and secondary impact crushing plants. The 5165LS shown above in this modern aggregate processing installation is a highly popular plant for secondary crushing applications.



This Lippmann impactor is a brute of a crusher that handles concrete full of rebar, asphalt and other C&D debris to produce highly saleable materials.

SUPERIOR QUALITY, MORE PORTABILITY AND BETTER FEATURES

4800 SERIES

The 4800 Series Impact Crushing Plants from Lippmann are the ultimate, completely self-contained, easy to transport crushing plants that offer the features contractors need, like a larger crusher feed opening that devours concrete full of rebar, ripped asphalt and other C&D debris.

The heart of the plant is a Lippmann 4248LP Impact Crusher, a brute that features a heavy duty rotor truly built to handle the daily punishment of recycled materials.

For aggregate applications, the 4248LP offers a greater reduction ratio and produces a high quality, uniform cubical product. Produce a variety of saleable material, including highly cubical Superpave aggregate, while lowering your cost per ton.

For maximum efficiency, performance, ease of transportability and easy set-up and tear down, the Lippmann 4800 will take you from job to job to make you more profitable! Ideal for small to medium size crushing projects.

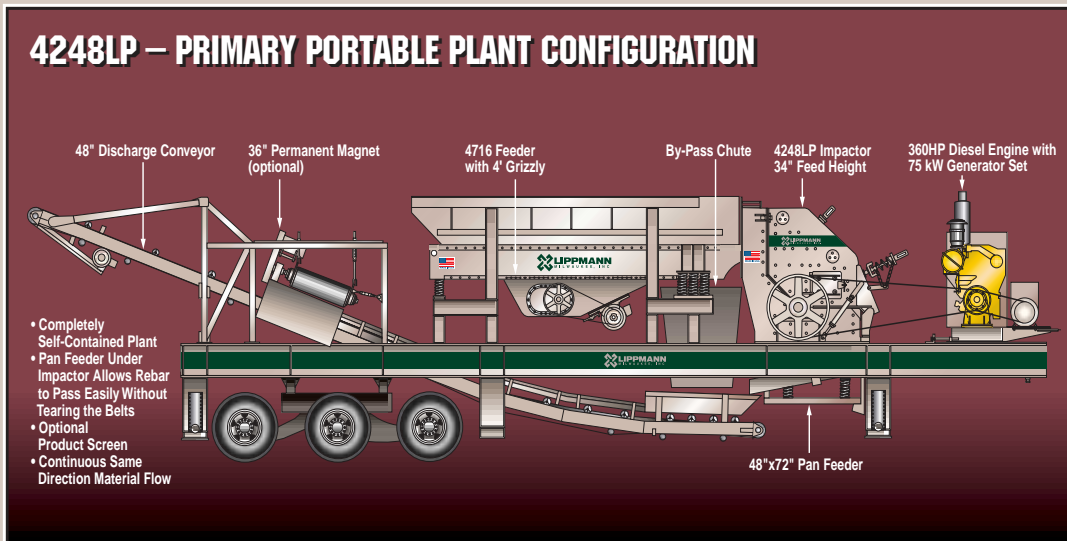

- Lippmann 4248LP Impactor with a True 34" x 48" Feed Opening.
- 4716 Feeder with 4' Grizzly and By-Pass Chute.
- 48" x 72" Pan Feeder Under the Impactor.
- 360HP Diesel, 75kW Generator Set.
- 48" Discharge Conveyor.
- 36" Permanent Magnet (optional).
- 62" x 10' Double Deck Inclined Scalping Screen (optional).
- 400 F Abrasion-Resistant Hopper.

FOR THOUSANDS LESS



4248 CC

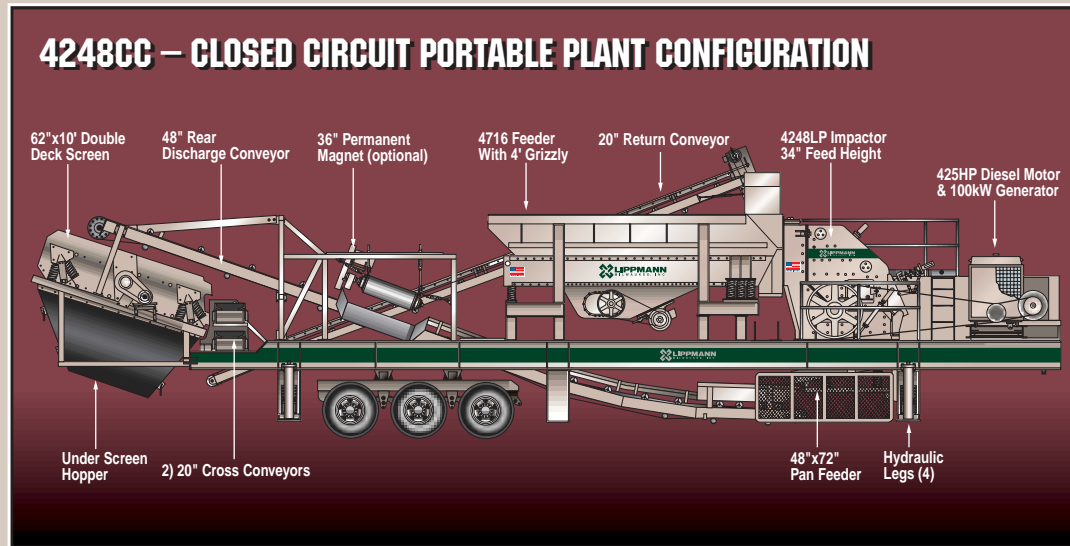

- Lippmann 4248LP Impactor with 34" Feed Height.
- 4716 Feeder with 4' Grizzly.
- 48" Rear Discharge Conveyor.
- 62"x10' Double Deck Screen with Under Screen Hopper.
- 20" Return Conveyor.
- 2) 20" Cross Conveyors.
- 48"x72" Pan Feeder Under the Impactor.
- 425 HP Diesel Motor and 100kW Generator.
- Hydraulic Legs.
- 36" Permanent Magnet (optional).
- Abrasion-Resistant Hopper.



4818 PRIME MOVER CRUSHING & SCREENING PLANT

The economical, multi-product 4818 Prime Mover self-contained crushing and screening plant handles all types of C&D debris and produces high quality, precisely-sized products.

- Lippmann 4248 Impactor.
- 45"x18' Heavy-Duty Grizzly Feeder with Quick Removal Hopper.
- 6'x16' Double-Deck Incline Screen.
- Removal On-Plant 350kW Generator.
- Conveyor That Travels On Plant.
- Cummins 460 HP Diesel Engine.

AN IMPACT CRUSHING PLANT TO SUIT EVERY CUSTOMER NEED

6500 SERIES

Lippmann's 6500 Series of portable impact crushing plants are engineered for high performance and superior transportability, ease of operation and versatility.

The Lippmann 5165LP primary portable crushing plant is a standard, cost effective unit for primary recycling of concrete or asphalt, and is available with hydraulic adjustment on the lower curtain. Various lengths of Lippmann feeders are available, as well as a discharge pan

feeder under the crusher. The 5165LP can also be used in the primary crushing of medium aggregate and sand and gravel applications.

The Lippmann 5165LS is a secondary recycle or aggregate plant which performs well with Lippmann's 3062 Jaw Plant in a two-stage recycle crushing application, or with a Lippmann 3048 Jaw Plant in a two-stage aggregate crushing operation. The 5165LS is available with double or triple deck screen.

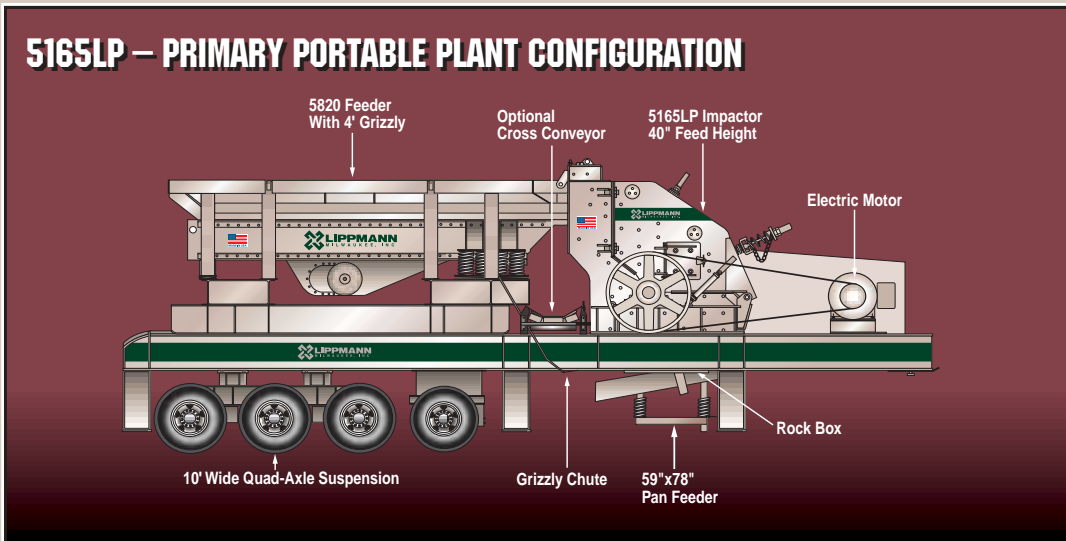

- Lippmann 5165LP Impactor with 40" Feed Height.
- Hydraulic Adjustment on Lower Curtain.
- 5820 Feeder with 4' Grizzly.
- Grizzly Chute.
- 59"x78" HD Pan Feeder.
- Optional Cross Conveyor.
- Rock Box.
- Electric Motor.
- 10' Wide Quad-Axle Suspension.
- 14' Travel Height.
- Abrasion-Resistant Hopper.

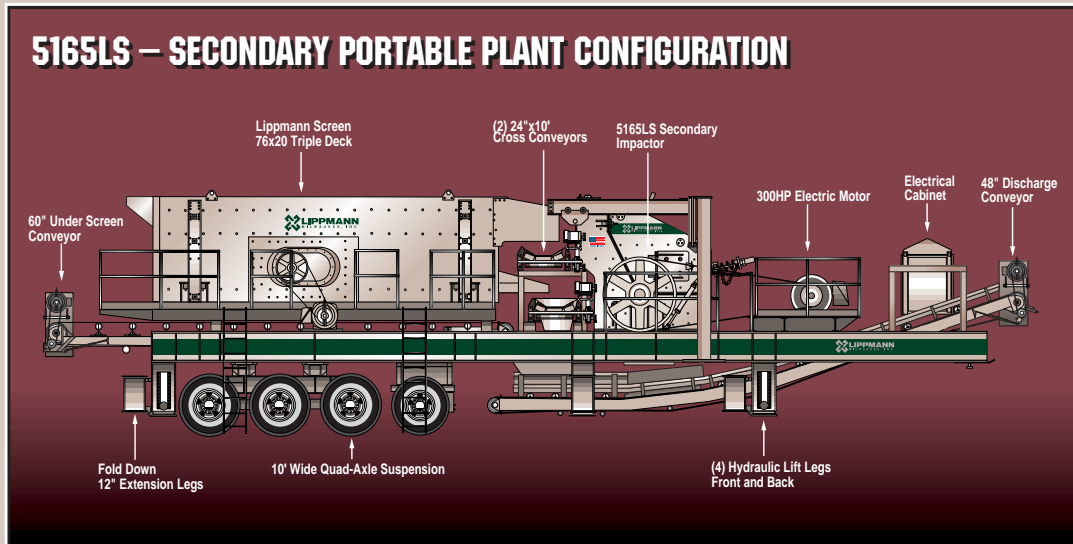

- Lippmann 5165LS Secondary Impactor.
- 76x20 Triple Deck Screen.
- 48" Discharge Conveyor.
- 60" Under Screen Conveyor.
- (2) 24"x10' Cross Conveyors.
- 300HP Electric Motor.
- Hydraulic Lift Legs.
- 10' Wide Quad-Axle Suspension.
- 13'11" Travel Height.
- Abrasion-Resistant Hopper.

SPECIAL APPLICATIONS

4236LS

From the smallest to the largest applications, Lippmann can solve your secondary crushing needs. The Lippmann 4236LS is ideal for secondary or tertiary (with third curtain) crushing of aggregate, asphalt, concrete, gravel or limestone. Just a foot narrower than our 4248LS, the 4236LS is a tremendous value for applications where lower capacity is required and lighter portability is desired. The 4236LS is a good solution for replacing a cone crusher on an existing cone chassis.



5196LS

The Lippmann 5196LS is a high tonnage secondary impactor, one of the widest in the industry, featuring an unusually wide feed opening. Built for ultra high capacity, the 5196LS can be used in most secondary crushing requirements including limestone, gravel, concrete and asphalt.



SUPERIOR 2-STAGE CRUSHING SOLUTIONS

Lippmann offers you today's best value in two-stage portable jaw/impact crushing systems. You can rely on quality machinery backed by the kind of personal, single source application expertise and product support only Lippmann can provide.

Lippmann custom engineers material processing systems mounted on heavy duty chassis which incorporate robust feeding, crushing, screening and conveying equipment designed for high productivity, easy transportability, quick set-up and tear down, and reduced wear costs. For recycling applications, plants feature magnetic separators, reinforced belting, special wear alloys and other options to suit your specific requirements.

If you're serious about recycle crushing or high productivity aggregate processing, count on Lippmann engineers to deliver two-stage crushing solutions resulting in desired capacities, product flexibility, minimum downtime and increased production.



PORTABLE, STATIONARY OR SKID MOUNTED, LIPPMANN OFFERS COST-EFFECTIVE SOLUTIONS FOR YOUR NEEDS



Skid-type units are gaining in popularity. Whether looking to avoid high permanent structure costs or considering easy relocation in the future, this may be your solution. Standard designs are available offering low profile, fold-up legs and ample platform area.



Feeding method is critical with an impact crusher. Optional feed chute designs are available to allow the impactor to be fed from three sides with a stacking conveyor.



If you are adding a bare crusher to a new stationary facility – or replacing an existing crusher, our impactor will be matched to your product requirements.

COMPONENTS... SIMPLE DESIGN WITH STANDARD PARTS

Simplicity of design, coupled with engineering focused on customer needs, assures you ease of maintenance and superior wear parts. Results are less downtime – more production time.

HAMMER LOCKING SYSTEM

The force of the jacking assembly causes all the hammers and backing beams to act as a solid mass when struck. This rigid, machined fit enables the use of more wear resistant, higher chrome hammers and yields more production before turning or replacing hammers.

HAMMER REPLACEMENT

Minimize the loss of valuable production time and labor. Vertical lift hammer replacement is one of the fastest and most efficient in the industry.



SHAFT ASSEMBLY

The rotor and shaft are held with keyless locking assemblies. Shaft is made of premium, high alloy steel. The keyless locking rings give superior locking capabilities over keyed shaft applications that experience impact bending loads. Keyless locking assemblies are easier to service.

HAMMER EFFICIENCY

Hammers are rectangular in shape with four wear edges. This shape will provide the most even production and product gradation. With proper usage of the four flips (three flips for the 5860LP), the machine utilizes the maximum amount of the hammer weight, thus giving efficient utilization of this wear component.

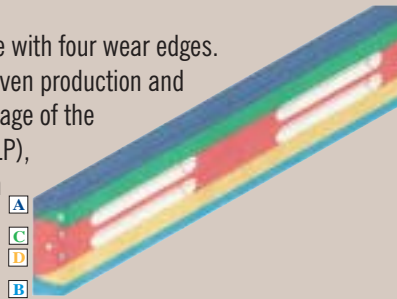

LINER RETENTION SYSTEM

Frame and apron liners are drilled and tapped and use standard hex head cap screws and lock washers. Bolted design stays tight longer as the liner wears. Liners are a premium, abrasion-resistant material. A monoblock curtain liner is also available.



GENUINE LIPPMANN PARTS – YOUR BEST VALUE

- The right wear and replacement parts at the right price.
- Immediate product support from people you know and trust, American owned.
- Unmatched availability, stocked right here in the U.S.
- Lippmann quality, dependability, high wear resistance and long life.
- Application expertise to help you maximize profits.

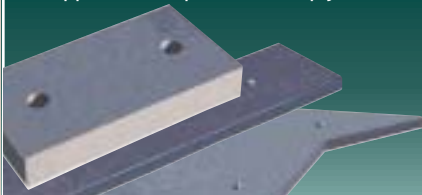

HYDRAULIC HOOD OPENING

Electric/hydraulic power unit and hydraulic cylinders are provided as standard for opening the hood, giving maximum space for maintenance. Rotor and hood locking devices are provided for added safety.

LIPPMANN MILWAUKEE, INC. HORIZONTAL SHAFT IMPACTORS

DIMENSIONS AND CAPACITIES

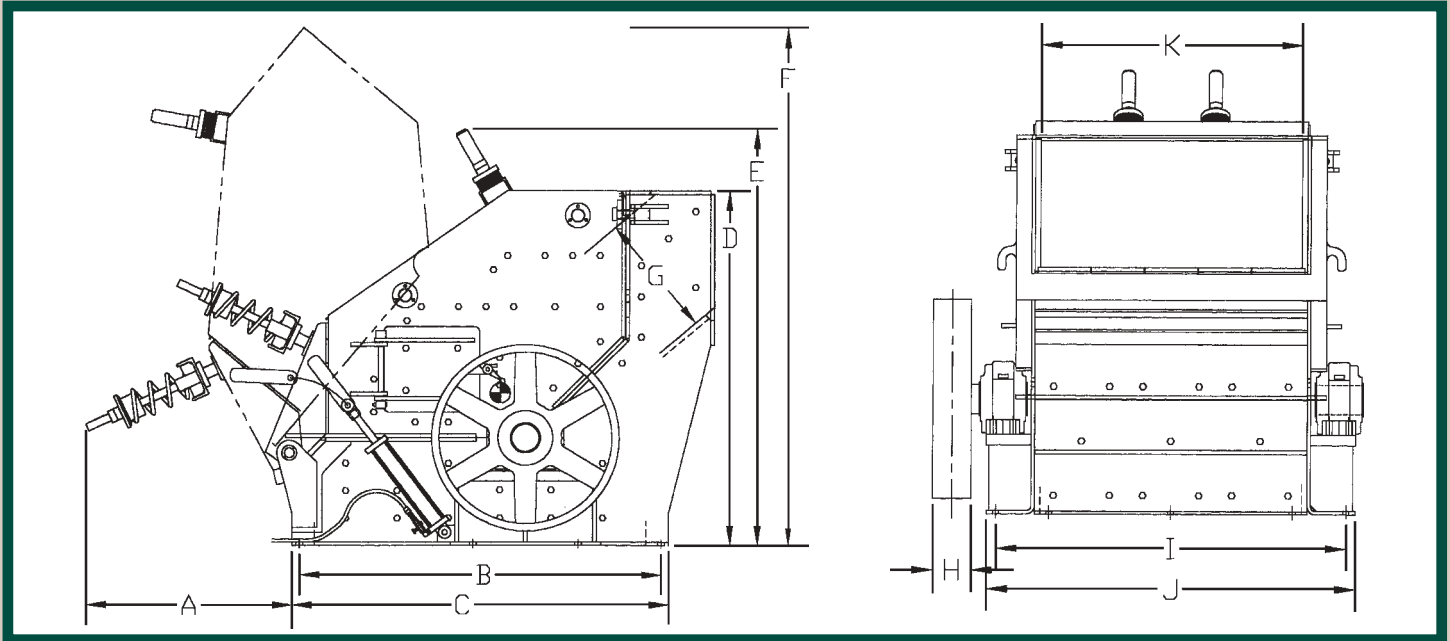

	Weight	HP	A	B	C	D	E	F	G	H	I	J	K
4236LS	15,900#	150	42"	72"	75"	71"	84"	104"	24"	4-7/16"	54-1/4"	57-3/4"	37-1/2"
4248LS	19,500#	200	42"	72"	75"	71"	84"	104"	24"	5-13/16"	66-1/4"	69-3/4"	49-1/2"
4248LP	24,000#	250	42"	72"	75"	84"	86-1/2"	112"	34"	5-13/16"	67-1/4"	70-3/4"	49-1/2"
5165LS	35,800#	300	45"	75"	79"	90"	99"	116"	31"	7-1/8"	86"	89"	66-1/2"
5165LP	45,000#	350	44"	86"	91-1/2"	95-1/2"	98"	129"	40"	7-1/8"	88"	90-1/2"	66-1/2"
5196LS	68,000#	400	44"	84"	89"	90"	95-1/4"	130"	31"	(2) 7-1/8"	108"	123"	97-1/2"

	Capacity	FEED SIZE				Min. Set
		Limestone	Gravel	Concrete	Asphalt	
4236LS	100-180	18"	10"	18"	20"	1-1/4"
4248LS	170-240	20"	12"	20"	20"	1-1/2"
4248LP	170-260	23"	12"	28"	28"	1-3/4"
5165LS	230-365	25"	14"	25"	25"	1-1/2"
5165LP	250-450	31"	16"	34"	34"	2"
5196LS	380-700	25"	14"	25"	25"	1-1/2"



LIPPMANN

MILWAUKEE, INC.

THE NAME YOU SHOULD KNOW FOR QUALITY CRUSHING MACHINERY

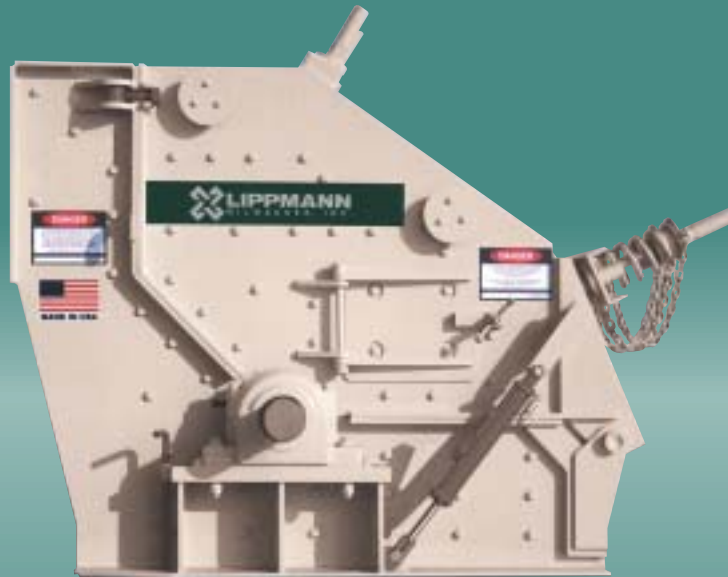

The information contained in this literature is meant to be general in nature and is not intended to be used for specific application, construction, or installation purposes. Please note that machine capacities, settings, and other application considerations can vary from the information contained in this literature, depending on the material being crushed, moisture, feed sizes, other materials in the feed, etc. As a result, no warranty of any kind, either expressed or implied, is extended with the information contained in this literature. Lippmann Milwaukee, Inc. expressly reserves the right to change specifications or designs without prior notice or obligation.



Lippmann Milwaukee, Inc.

3271 East Van Norman Ave. • Cudahy, WI 53110-0586
(800) 648-0486 • (414) 744-2565 • Fax: (414) 744-8172
Visit our web site at: www.lippmann-milwaukee.com



Sold & Serviced By: