

COMPACT TRACK LOADER

TL6R

TAKEUCHI

From World First to World Leader



Product Features & Specifications

ENGINE

- U.S. EPA Final Tier 4 Emission Compliant
- Turbocharged
- DOC+DPF Exhaust After Treatment
- Active Power Control Power Management System
- Working Modes - Power and ECO
- Automatic Fuel Bleed System
- High Capacity Radiator and Hydraulic Oil Cooler Mounted Side-by-Side on Swing Out Frame
- Dual Element Air Filter

ELECTRICAL

- Multi-Informational Display
- Sealed Rocker Switches
- 12 volt System with 60 amp Alternator
- Work Lights, Front and Rear
- Engine Preheat
- Hour Meter
- Back-up Alarm
- Horn

TAKEUCHI FLEET MANAGEMENT

- 2 Year Standard Service
- Minimize Downtime
- Remote Diagnostics
- Utilization Tracking
- Proactive Maintenance
- Control Costs

UNDERCARRIAGE AND FRAME

- Permanently Sealed Track Rollers with Metal Face Seals
- Double and Triple Flange Track Rollers
- Fully Welded Frame with Integrated Cross Members
- Front and Rear Tie-Down and Lift Points
- Integrated Rear Bumper
- Two-Speed Travel
- 12.6" Quiet Ride Track Design

OPERATOR'S STATION

- Tilt-up Operator's Station
- Deluxe Adjustable Suspension Seat
- Rear Pivoting Seat Bar with Integrated Arm Rest
- ROPS / FOPS Structure
- Retractable 2" Seat Belt
- Retractable 3" Seat Belt (optional)
- 3 Point Retractable Seat Belt (optional)
- Pressurized Cab with Swing Out Door, A/C, Heat, Defrost and Front Wiper, AM/FM/MP3 Radio with NOAA Weatherband (optional)

HYDRAULIC & WORKING EQUIPMENT

- Cushioned Boom Cylinders
- Boom Float with Detent
- Hydraulic Pilot Controls
- Proportional Auxiliary Controls with Detent
- Pressure Relieving 1/2" Flat Faced Coupler Body
- 14-Pin Connector
- Hydraulic Self Leveling
- Mechanical Quick Coupler (Canopy)
- Hydraulic Quick Coupler
 - Cab - Standard Equipment
 - Canopy - optional



Convenient Service and Maintenance Access

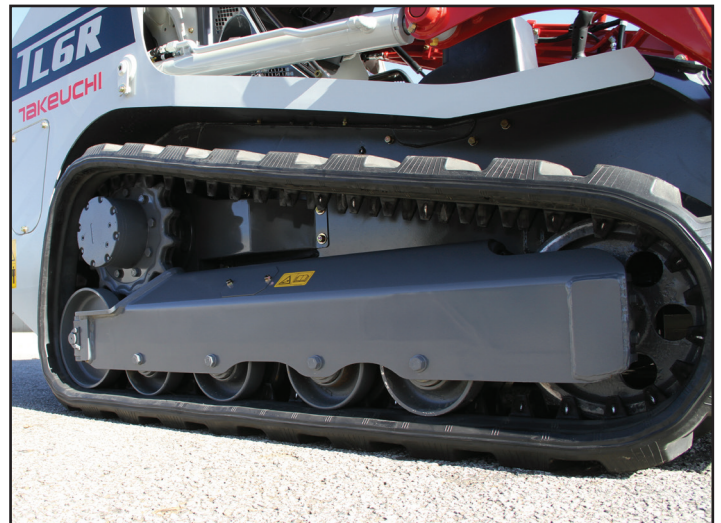

Integrated Undercarriage

TOUGH, RUGGED, EFFICIENT

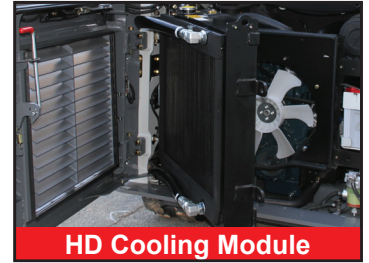
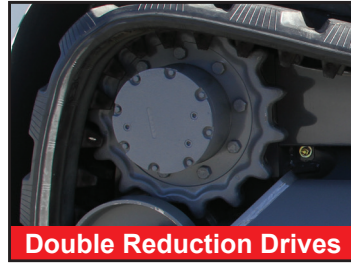

The TL6R provides an excellent blend of power and performance featuring a Final Tier 4 emission compliant 65 hp engine that is well matched to this 7,480 lbs, radial lift loader. It has a bucket breakout force of 5930 lb and traction force of over 8650 lb giving it plenty of power to excavate, grade, and maneuver on the job site. With a height of 6 ft 5.8 in and a width of just over 5 ft the dimensions of the TL6R allow it to excel on job sites with height and width restrictions. The interior of the machine has rocker switches and color multi-informational

display laid out intuitively overhead within easy reach of the operator. Pilot controls deliver unmatched precision and control, and they are low effort to minimize operator fatigue. A rear view camera and wide angle rear view mirror provide the operator with greater peace of mind during operation, and the Takeuchi Fleet Management System (TFM) allows the machine to be managed remotely for health, service and maintenance, location, and operating hours minimizing downtime and helping to control costs.



Spacious operator's platform with easy to reach controls and switches.

OPERATING PERFORMANCE

Operating Weight - Canopy	7,485 lb	(3,395 kg)
Cab	7,780 lb	(3,530 kg)
Tipping Load	5,269 lb	(2,390 kg)
Rated Operating Capacity, SAE J818*	1,841 lb	(835 kg)
Operating Load at 50% of Tipping Load	2,635 lb	(1,195 kg)
Bucket Breakout Force	5,930 lb	(2,690 kg)
Lift Arm Breakout Force	4,860 lb	(2,205 kg)
Traction Force	8,655 lb	(3,926 kg)
Ground Pressure - Canopy	4.9 psi	(33.5 kPa)
Ground Pressure - Cab	5.1 psi	(34.8 kPa)
Travel speed - Low	4.3 mph	(7.0 km/hr)
High	6.2 mph	(10.0 km/hr)

*Operating capacity of track loaders is rated according to SAE J818 at no more than 35% of the tipping load.

HYDRAULIC SYSTEM

Auxiliary Flow - Primary Circuit	17.8 gpm	(67.4 Lpm)
Hydraulic System Pressure	2,988 psi	(20.6 MPa)

ENGINE

Make / Model	Kubota / V2403-CR-TE4B
Engine Displacement	148.5 cu in (2.4 L)
Horsepower @ 2,700 rpm	65.2 hp (48.6 kW)
Maximum Torque @ 1,500 rpm	144.3 ft-lb (195.6 Nm)

FLUID CAPACITIES

Engine Lubrication	7.6 qt	(7.2 L)
Cooling System	14.0 qt	(13.0 L)
Fuel Tank Capacity	20.0 gal	(75.7 L)
Fuel Consumption (65% of Full Load)	2.69 gal/hr	(10.2 L/hr)
Hydraulic Reservoir Capacity	7.9 gal	(30.0 L)
Hydraulic System Capacity	13.5 gal	(51.0 L)



Multi-Informational Display



Pilot Operated Controls



Cab with Swing Out Door

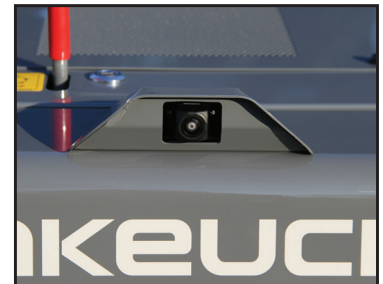

Rear View Camera

ATTACHMENTS

Takeuchi now offers attachments for all of your Takeuchi equipment. See your authorized Takeuchi dealer for additional information and attachment options.

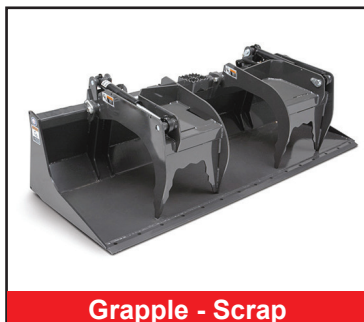

Grapple - Scrap



Dozer Blades



Pallet Forks

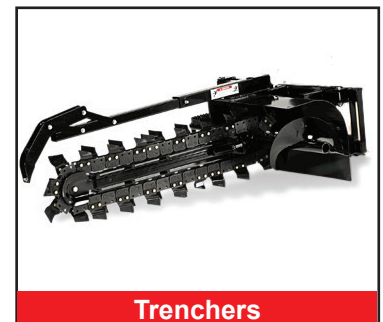

Trenchers

TL6R Compact Track Loader

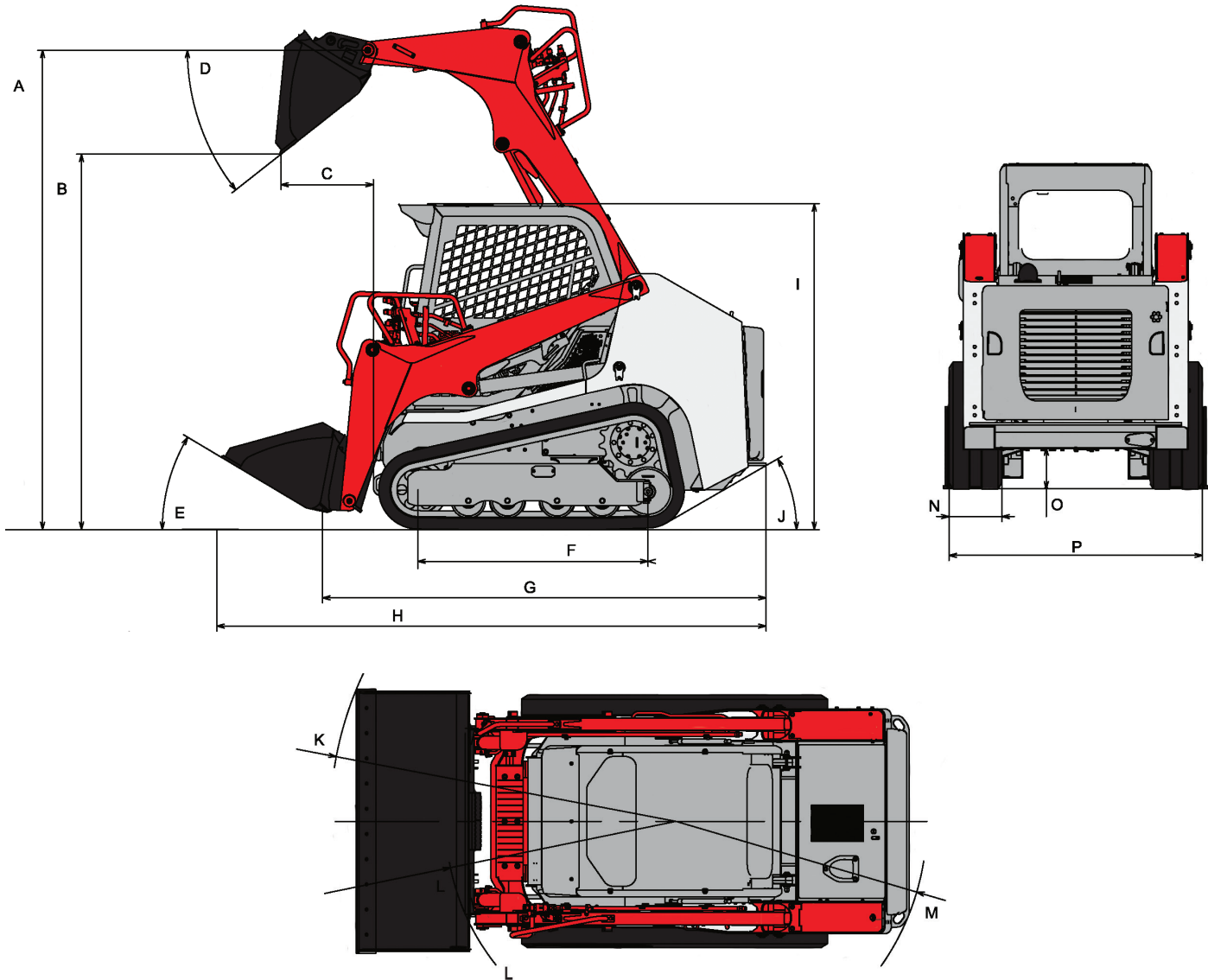

MACHINE DIMENSIONS

A	Maximum Lift Height to Bucket Pin	9 ft 6.4 in	(2,905 mm)
B	Dump Height Fully Raised	7 ft 5.6 in	(2,275 mm)
C	Dump Reach Fully Raised	1 ft 10.0 in	(560 mm)
D	Dump Angle	38°	
E	Rollback Angle	31°	
F	Track Ground Contact Length	4 ft 6.9 in	(1,395 mm)
G	Machine Length	8 ft 9.9 in	(2,689 mm)
H	Transport Length	10 ft 11.1 in	(3,330 mm)
I	Transport Height	6 ft 5.8 in	(1,975 mm)
J	Departure Angle	30°	
K	Clearance Circle with Bucket	6 ft 10.5 in	(2,095 mm)
L	Clearance Circle without Bucket	4 ft 6.9 in	(1,395 mm)
M	Clearance Circle Rear	4 ft 11.8 in	(1,520 mm)
N	Track Width	12.6 in	(320 mm)
O	Ground Clearance	9.1 in	(230 mm)
P	Overall Width without Bucket	5 ft 0.2 in	(1,530 mm)



2 YEAR
2,000 HOUR
FULL MACHINE
WARRANTY



© 2017 Takeuchi Manufacturing (U.S.), Ltd. All Rights Reserved. Printed in the U.S.A. In accordance with our established policy of continued improvement, specifications and features are subject to change without notice. Pictures may show options other than standard equipment.

FORM: TL6R Compact Track Loader Spec Sheet - Dec. 2017

TAKEUCHI
From World First to World Leader